



ATEQ F620

Quick Start Guide





Table of contents

Safety advisory / Warranty

Good practices and safety instructions.....	4
Air quality requirements.....	5

Preamble

ATEQ F620, a universal leak tester.....	6
Leak test.....	7
Principle of a cycle.....	8

Your ATEQ F620

Front panel.....	9
Connectors on the back panel (with all options).....	10
Power supply connectors.....	12
Digital links.....	14
Analog outputs.....	17
Digital inputs/outputs.....	18
Pneumatic connectors.....	22
Pneumatics configuration.....	25

User interface

Overview.....	32
Keys.....	32
Display.....	33

Starting up

Power up.....	35
Preparing a program.....	35
Modifying a parameter.....	36
Selecting a program.....	37
Starting and stopping current cycle.....	37

User adjustments



Options of the menus.....	38
---------------------------	----

Specifications

Characteristics.....	45
----------------------	----



ATEQ Manufacturer Plants - Measurement Solution, Global Leader.

		
ATEQ 15, rue des Dames, Z.I. 78340 LES CLAYES-SOUS-BOIS FRANCE	info@ateq.com ateq.com	T.: +33 1 30 80 1020 F.: +33 1 30 54 1100
ATEQ K.K. 3 - 41 ATEQ Building, Ikehata Chiryu-city, Aichi-pref JAPAN	info@ateq.co.jp ateq.co.jp	T.: +81 566-84-4670 F.: +81 566-84-4680
ATEQ China 98 Jian Peng Lu Shanghai CHINA	shanghai@ateq.com.cn ateq.com.cn	T.: +86 21 6763 9508 F.: +86 21 6763 9528
ATEQ SYSTEMS ANALYSIS TAIWAN CO., LTD. NO. 3, LAN 223, San Jia Dong Street 40642, TAICHUNG TAIWAN	ateqtaiwan@ateq.com.tw ateq.com.tw	T.: +886 4 2437 5278 F.: +886 4 2437 3675
ATEQ CORP. 35980 Industrial Road Suite L Livonia MI 48150 UNITED STATES	leaktest@atequsa.com atequsa.com	T.: +1 734-838-3100 F.: +1 734-838-0644

 We continuously work on improving our products. This is why information contained in this manual, the device and the technical specifications may be modified without prior notification.

 Pictures and figures in this manual are non-contractual.





Safety advisory / Warranty

4/46

GOOD PRACTICES AND SAFETY INSTRUCTIONS

Safety recommendations

-  If the device is supplied with 100 / 240 V AC, it is mandatory to connect it to the ground with a good link to the ground, to protect against electric hazard or electrocution.
-  It is dangerous to change the status of the outputs.
They can control power actuators or other equipment (mechanical, pneumatic, hydraulic, electrical or other) which can cause serious personal injury and damage to surrounding material.
-  For safety and quality measurement reasons, it is important, before powering on the device, to ensure that it is air supplied with a minimum operating pressure (0.6 MPa (87 PSI) \pm 15%).

Recommendations for the test environment

Keep the test area as clean as possible.

Recommendations for operators

ATEQ recommends that the operators who use the devices have training and a level of qualification that correspond to the job to perform.

General recommendations

- Read the user manual before using the device.
- All electrical connections to the device must be equipped with safety systems (fuses, circuit breakers, etc.) adapted to the needs and in accordance with the applicable standards and rules.
- To avoid electromagnetic interference, electrical connections to the device must be shorter than 2 meters.
- Power supply plug must be grounded.
- Disconnect the device from the mains before performing any maintenance work.
- Shut off the compressed air supply when working on the pneumatic assembly.
- Do not open a connected device.
- Avoid splashing water on the device.

ATEQ is at your disposal for any information concerning the use of the device under maximum safety conditions.

We draw your attention to the fact that ATEQ cannot be held responsible for any accident related to a misuse of the measuring instrument, the workstation or non-compliance of the installation with safety rules.

In addition, ATEQ declines any responsibility for the calibration or the fitting of their instruments that is not done by ATEQ.



ATEQ also declines any responsibility for any modification (program, mechanical or electrical) of the device done without their written consent.



AIR QUALITY REQUIREMENTS

The air supplied into the device must be clean and dry. Even though the device is provided with a filter, the presence of dust, oil or impurities may cause malfunction.

Air quality requirements according to ISO standard 8573

-  The air must be clean and dry.
-  The presence of impurities, oil or humidity in the air may cause deterioration which will not be covered by the warranty.
-  When the instrument is working in vacuum conditions, impurities must be prevented from being drawn into its internal components.
For this purpose we strongly recommend that a suitable airtight filter is installed between the part under test and the instrument.

ATEQ recommends the following characteristics for the air supplied into the device.

Air characteristics		ISO standard 8573 class
Grain size and concentration	0.1 μm and 0.1 mg/m ³	Class 1
Dew point under pressure	- 40°C dew	Class 2
Maximum concentration of oil	0.01 mg/m ³	Class 1

Recommended additional equipment

ATEQ recommends the installation of this additional equipment:

- Air dryer to provide dry air at less than - 40°C dew point
- 25 micron and 1/100 micron double filter.



Preamble

6/46

ATEQ F620, A UNIVERSAL LEAK TESTER

ATEQ F620 is a leak detector that tests the airtightness of parts.



ATEQ F620 can memorise 128 different test programs.



LEAK TEST

Direct measurement principle

7/46

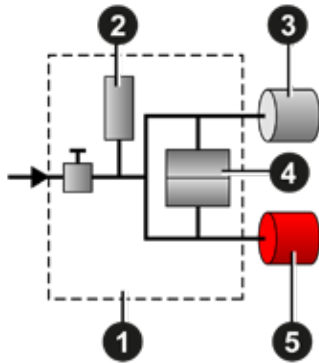

The part under test **3** and the reference part **5** are filled to an identical pressure. A differential sensor **4** measures the pressure variation between the part under test **3** and the reference part **5**. In some applications, the reference part can be replaced by a cap.

- 1 Device
- 2 Pressure sensor
- 3 Part under test
- 4 Differential pressure sensor
- 5 Reference part

Desensitized test

This mode is used for the measurement of large leaks, when the reject level required is above the full scale of the differential sensor.

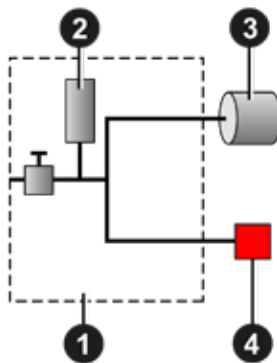

The test pressure is applied to the input of the test part **3**.

The measurement is performed by the pressure sensor **2**.

- 1 Device
- 2 Pressure sensor
- 3 Part under test
- 4 Cap on the reference connector

Other types of test are available in option (Burst test, Volume, Operator...).



PRINCIPLE OF A CYCLE

The measurement cycle is made of 4 main phases: fill, stabilization, test, dumping.

8/46

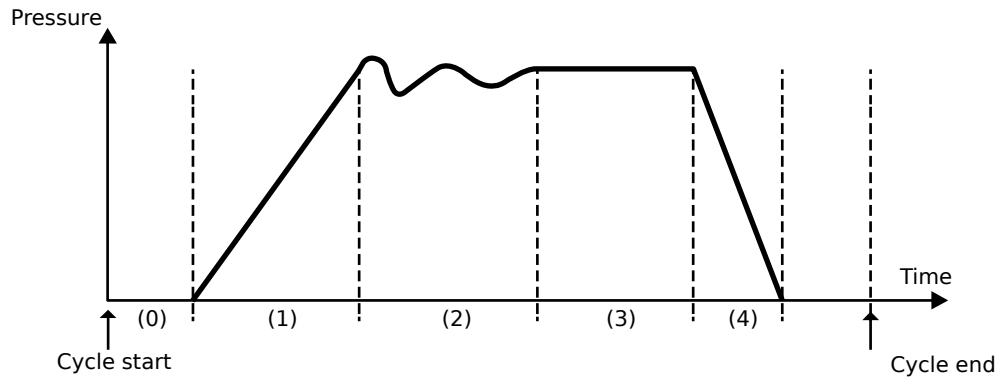

- 0 Waiting phase
- 1 Fill phase
- 2 Stabilization phase
- 3 Test
- 4 Dumping



Your ATEQ F620

FRONT PANEL

The user interface is located on the front panel.



- 1 Display
- 2 Cycle keys
- 3 Navigation keys
- 4 USB connectors
- 5 Quick connector
- 6 Mechanical Regulator

i For more information, refer to User interface



CONNECTORS ON THE BACK PANEL (WITH ALL OPTIONS)

10/46

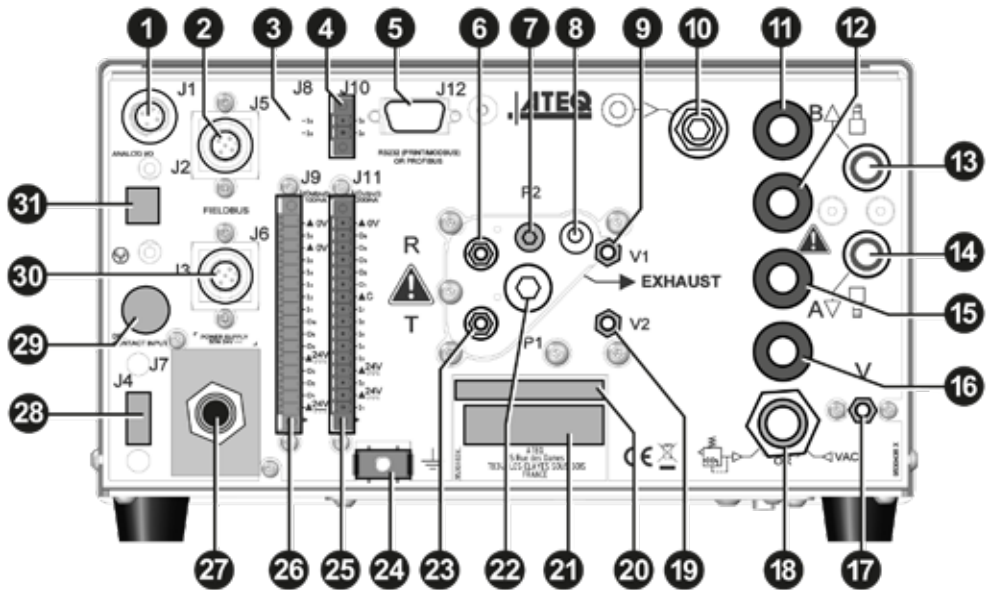



Ref	Name	Description
1	J1	Analog outputs - pressure and leak (option)
2	J5	Fieldbus connector
3	J8*	Extender (not operational)
4	J10	Program selection extension connector (option)
5	J12	Printer RS232 connector / Modbus (option) or Profibus (option)
6	R	Reference part connector
7	P2	Not used
8	-	Exhaust output
9	V1	Differential sealed part connector (option)
10	-	Input connector to the air filter (valves or regulator air supply)
11	-	Pilot pressure input or test pressure input (according configuration)
12	-	Test pressure output (indirect mode)
13	B	Pneumatic output for B automatic connector option
14	A	Pneumatic output for A automatic connector option
15	-	Pneumatic input or output (according configuration)
16	-	Exhaust output (indirect mode)
17	V	Calibration check by volume variation connector (option)
18	-	Vacuum input or external regulated pressure (according configuration)
19	V2	Differential sealed part connector (option)
20	-	Part number / Serial number
21	-	Air supply energy information
22	P1	Pressurization output
23	T	Test part connector
24	-	Ground
25	J11	Relay board connector (digital inputs/outputs and 24 V DC - 2 A power supply)
26	J9	Outputs code board connector (digital inputs/outputs)
27	J7	Connector for 24 V DC - 2 A or 100 / 240 V AC power supply (according option provided)
28	J4*	USB (not operational)
29	J3*	Special IO (not operational)
30	J6	Fieldbus connector
31	J2*	Network (not operational)



* These connectors are not operational. They are provided for future development of our devices.





POWER SUPPLY CONNECTORS

The device can be connected to an external power supply (24 V DC - 2 A) or provided with an internal power supply (100 / 240 V AC) (option).

12/46

External supply

24 V DC connector (J7)

The device can be connected to a 24 V DC - 2 A power supply through a M12 4 pins type connector.

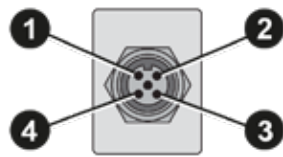

Pin number	Signal
1	Not connected
2	+ 24 V DC
3	Not connected
4	Ground: 0 V

24 V DC on the relay board connector (J11) (option)

The device can also be connected to a 24 V DC - 2 A power supply through J11 connector on the relay board.

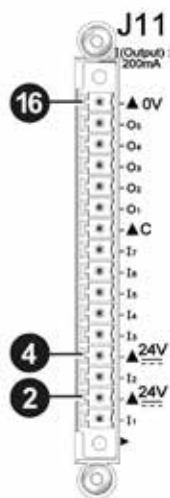

Pin number	Signal
2	+ 24 V DC
4	+ 24 V DC
16	Ground: 0 V

i | Apply 24 V DC to the pin **2** or **4**.



Internal supply only

100 / 240 V AC connector (J7) (option)

The device can be connected to a 100 / 240 V AC power supply (option).

This connector has a ON/OFF button.



It is mandatory to connect the device to the ground with a good link to the ground, to protect against electric hazard or electrocution.



1 ON
0 OFF



DIGITAL LINKS

PC USB connectors (on front face)

USB connectors can be used for connecting miscellaneous compatible USB devices. The USB connectors are located under the rubber cover **1** (see figure).

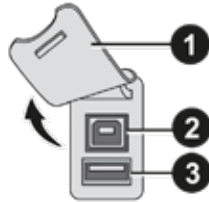

- 1** Rubber cover
- 2** USB connector to PC
- 3** USB connector to USB key

 Do not connect two USB devices at the same time.

 Do not use a cable longer than 2 m.

 Push the rubber cover **1** slightly forward for an easy access to USB connectors **2** and **3**.

 Only use this connection for temporary communication. Connection to a PC cannot be used permanently because the communication can be disconnected by the PC.

Printer RS232 connector / Modbus (option) or Profibus (option) (J12)

RS232 - SubD 9 pins male connector (printer)

RS232 for printer, bar code reader, PC connection.

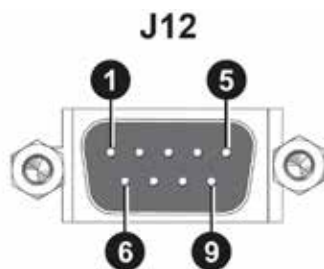

Pin number	Signal
1	Not used
2	RXD data input
3	TXD data input
4	Not used
5	Ground
6	Not used
7	RTS request to send
8	CTS clear to send
9	Not used



RS232 - SubD 9 pins female connector (Profibus) option

Profibus: SubD 9 pins female connector.

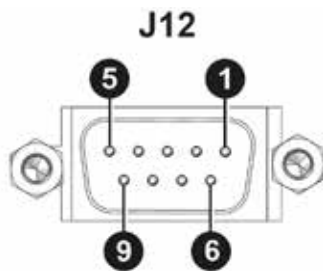

Pin number	Signal
1	PE (ground)
2	Not used
3	Data line A
4	CNTR - A (repeater control signal)
5	DGND (logic ground)
6	VP (supply)
7	Not used
8	Data line B
9	Not used

Devicenet connectors (J5) (J6) (option)

M12 type connector - 5 pins male connector (J5) (Devicenet input)

For connection to others ATEQ devices.

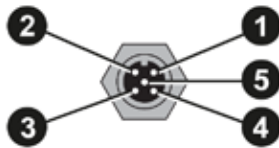

Pin number	Signal
1	Drain
2	V+
3	V-
4	CAN_H
5	CAN_L

M12 type connector - 5 pins female connector (J6) (Devicenet output)

For connection to others ATEQ devices.

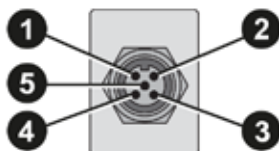

Pin number	Signal
1	Drain
2	V+
3	V-
4	CAN_H
5	CAN_L



Profinet connectors (J5 + J6) (option)

M12 D coded type connector - 4 pins female connector (J5 + J6)

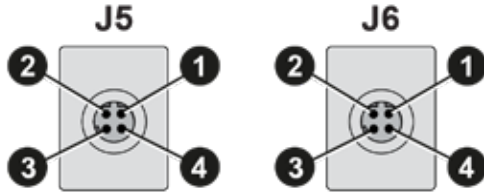

Pin number	Signal
1	Ethernet Tx + (Transmit Data +)
2	Ethernet Rx + (Receive Data +)
3	Ethernet Tx - (Transmit Data -)
4	Ethernet Rx - (Receive Data -)

Ethernet connector (J5 + J6) (option)

Standard connection Ethernet TCP / IP protocol.



One of these network protocols is available:

- Ethernet IP
- Profinet
- Ethercat (J5 = Input J6 = Output).



ANALOG OUTPUTS

M12 type connector - 8 pins female connector (J1)

17/46

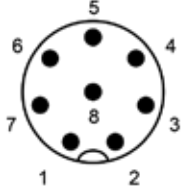

Pin number	Signal
1	Ground Pressure
2	0 - 10 V DC Pressure
3	Ground Pressure (Diff)
4	0 - 10 V DC Pressure (Diff)
5	Signal contact event
6	Ground contact event
7	Other options
8	Other options



DIGITAL INPUTS/OUTPUTS

The 24V DC power supply for the digital inputs can be provided by 2 means:

- The internal power supply of the device (0.3A max)
- An external power supply provided by the customer.

i | Inputs default mode is PNP. NPN mode is available on request.

Relay board connector (J11) (option)

Characteristics

- Inputs
 - Activation: + 24 V DC.
- Outputs
 - Dry contacts
 - 60 V AC / DC max - 200 mA max.

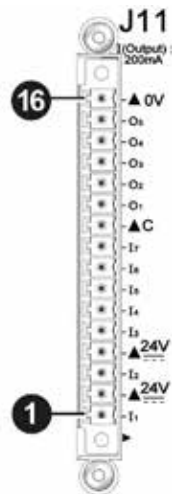

Pin number	Inputs / outputs	Description
1	Input 1	RESET
2	+ 24 V DC	Common
3	Input 2	START
4	+ 24 V DC	Common
5	Input 3	Program selection
6	Input 4	Program selection
7	Input 5	Program selection
8	Input 6	Program selection
9	Input 7	Program selection (programmable input)
10	Output	Common floating output
11	Output	Pass part
12	Output	Test fail part
13	Output	Reference fail part



Pin number	Inputs / outputs	Description
14	Output	Warning
15	Output	End of cycle
16	0 V	Ground

- i** The device can be energized through the **J11** connector of the relay board (except if internal supply option):
0 V to the pin **16**
24 V DC to the pin **2** or **4**.

Program selection extension connector (J10) (option)

The J10 connector is an extension of the J11 connector that enables the selection of 128 programs.

Characteristics

- Inputs
 - Activation: + 24 V DC.

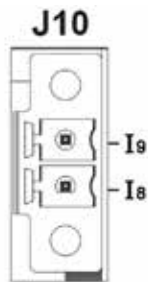

Pin number	Inputs/outputs	Description
I8	Input 8	Program selection from 33 to 64 (programmable input)
I9	Input 9	Program selection from 65 to 128 (programmable input)



Program selection (J11 and J10)

The connectors J11 and J10 (option) enable you to select a program from digital inputs. Combinations of connector pins to activate for program selection

20/46

Program number	J11					J10	
	Pin 5 (input 3)	Pin 6 (input 4)	Pin 7 (input 5)	Pin 8 (input 6)	Pin 9 (input 7)	Pin 1 (input 8)	Pin 2 (input 9)
1	0	0	0	0	0	0	0
2	1	0	0	0	0	0	0
3	0	1	0	0	0	0	0
4	1	1	0	0	0	0	0
5	0	0	1	0	0	0	0
6	1	0	1	0	0	0	0
7	0	1	1	0	0	0	0
8	1	1	1	0	0	0	0
9	0	0	0	1	0	0	0
10	1	0	0	1	0	0	0
11	0	1	0	1	0	0	0
12	1	1	0	1	0	0	0
13	0	0	1	1	0	0	0
14	1	0	1	1	0	0	0
15	0	1	1	1	0	0	0
16	1	1	1	1	0	0	0
17 to 32	X*	X	X	X	1	X	X
33 to 64	X	X	X	X	X	1	X
65 to 128	X	X	X	X	X	X	1

 *X is equal to 0 or 1 in function of the program number.



Valve codes and auxiliary outputs board connector (J9) (option)

Characteristics

- Outputs:
 - 24 V DC - 100 mA max per output.
- Inputs:
 - Activation: + 24 V DC.

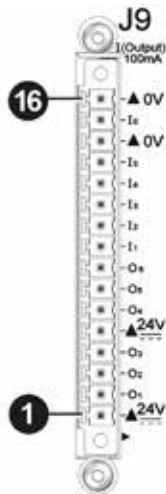

Pin number	Inputs / outputs	Description
1	+ 24 V DC	Common (outputs 1, 2,3)
2	Output 1	Open collector
3	Output 2	Open collector
4	Output 3	Open collector
5	+ 24 V DC	Common (outputs 4, 5, 6)
6	Output 4	Open collector
7	Output 5	Open collector
8	Output 6	Open collector
9	Input 1	Programmable input
10	Input 2	Programmable input
11	Input 3	Programmable input
12	Input 4	Programmable input
13	Input 5	Programmable input
14	0 V	Ground
15	Input 6	Programmable input
16	0 V	Ground



PNEUMATIC CONNECTORS

Pneumatic connectors used to connect the part under test are located on the back panel of the device.

22/46

Pneumatic supply



The pneumatic supply has to meet specific requirements recommended by ATEQ. Refer to Good practices and safety instructions section.
A specific filter may be necessary.

The air is supplied via the filter located on the back panel of the device.

Metal air filter



The metal filter is used for 1 MPa (145 PSI) range.
The maximum pressure admissible is 1.2 MPa (174 PSI).

Plastic air filter



The plastic filter is used for 0.5 MPa (72.5 PSI) range (direct and indirect modes) or 2 MPa (290 PSI) range (for pilot valves input).
The maximum pressure admissible is 690 kPa (100 PSI).



Quick connector (on front face) (option)

Use this function to check the calibration.



 As this connector is part of the measurement circuit, all its connections must be air tight.

Test and reference outputs

The outputs enables parts to be connected (test and reference)

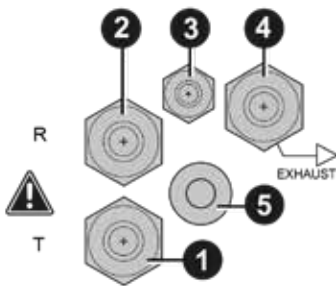

- 1 Test connector
- 2 Reference connector
- 3 Not used
- 4 Exhaust output
- 5 Pressurization output

Metallic fitting available for test (1) and reference (2) connectors:

- 2.7/4 mm
- 3/5 mm
- 4/6 mm
- 6/8 mm

Differential sealed part connectors (option) (V1 and V2)

External volume (closed tube) connection.

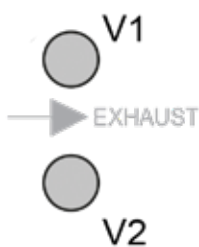

Metallic fitting available for V1 and V2 connectors:

- 2.7/4 mm



Other inputs / outputs

The outputs enables parts to be connected (test and reference)

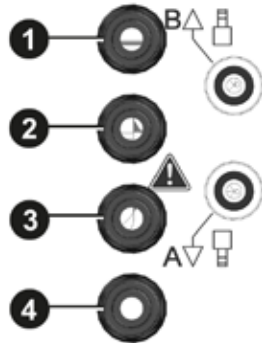

- 1 Pilot pressure input or test pressure input (according configuration)
- 2 Test pressure output (indirect mode) (from 0.5 to 2 MPa (72.5 to 290 PSI) according configuration)
- 3 Pneumatic input or output (according configuration)
- 4 Exhaust output (indirect mode)

Pneumatic output 0.6 MPa (87 PSI) (option)



A and B: automatic connectors option. These connectors are used to drive pneumatic caps on the part under test.

Air supply input for options

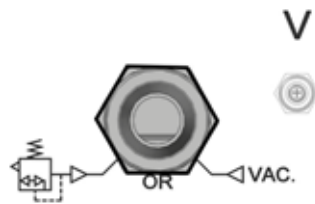

Instant fitting: 6 mm diameter
– Vacuum input for vacuum range
– External regulated pressure (according configuration)

Calibration check by volume variation connector (option) (V)

External volume (closed tube) connection.

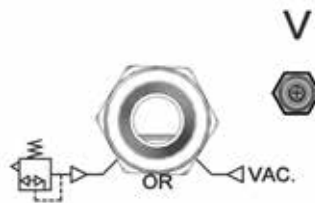



PNEUMATICS CONFIGURATION

Direct mode - Low range

Pressure: from 0 to 500 kPa (72.5 PSI)

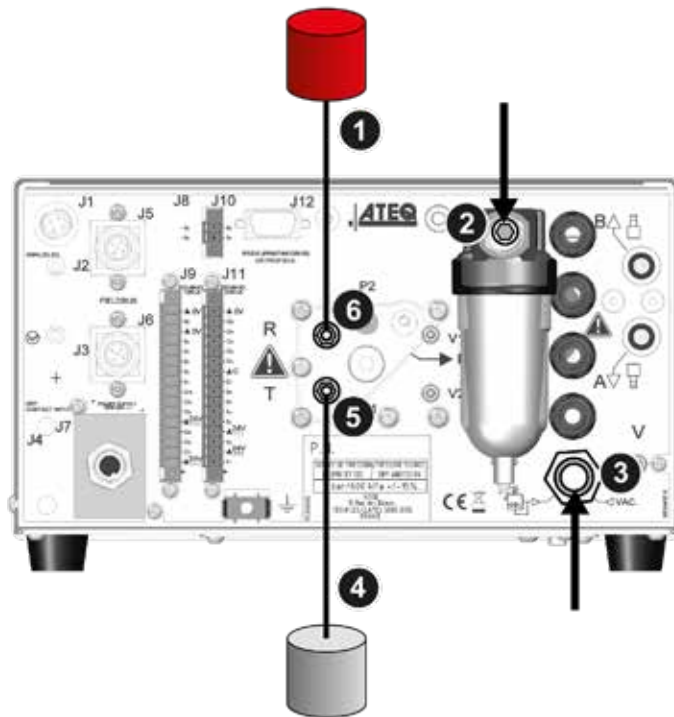

Connections

Connection	Option / description
6 to 1	Connection of the reference output to the reference part
5 to 4	Connection of the test output to the part under test
Air supply to 2	Connection of the air supply to the filter input (0.6 MPa (87 PSI))
Vacuum to 3	Connection to the vacuum (option)



Direct mode - Medium range

Maximum pressure: 1 MPa (145 PSI)

26/46

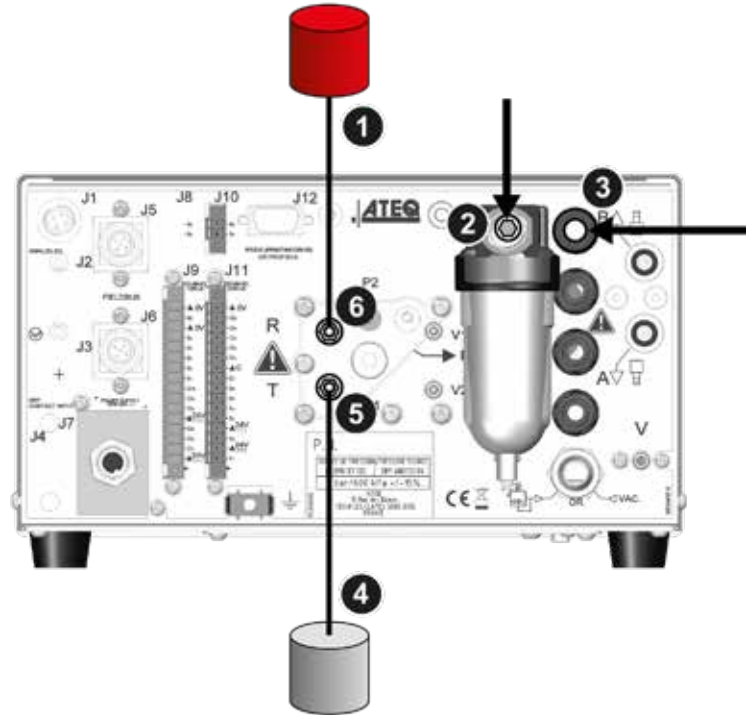

Connections

Connection	Option / description
6 to 1	Connection of the reference output to the reference part
5 to 4	Connection of the test output to the part under test
Regulator air supply to 2	Connection of the regulator air supply to the filter input (1.2 MPa (174 PSI))
Air supply to 3	Connection of the air supply (0.6 MPa (87 PSI))



Direct mode - High range

Maximum pressure: 2 MPa (290 PSI)

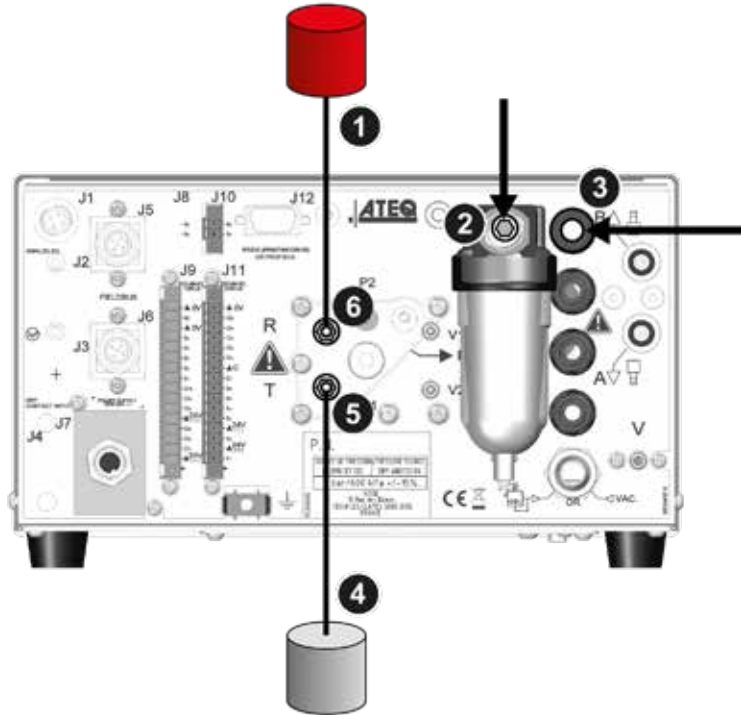

Connections

Connection	Option / description
6 to 1	Connection of the reference output to the reference part
5 to 4	Connection of the test output to the part under test
Air supply to 2	Connection of the air supply to the filter input (0.6 MPa (87 PSI))
Regulator air supply to 3	Connection of the regulator air supply (2 MPa (290 PSI))



Indirect mode

Maximum pressure: 1 MPa (145 PSI)

28/46

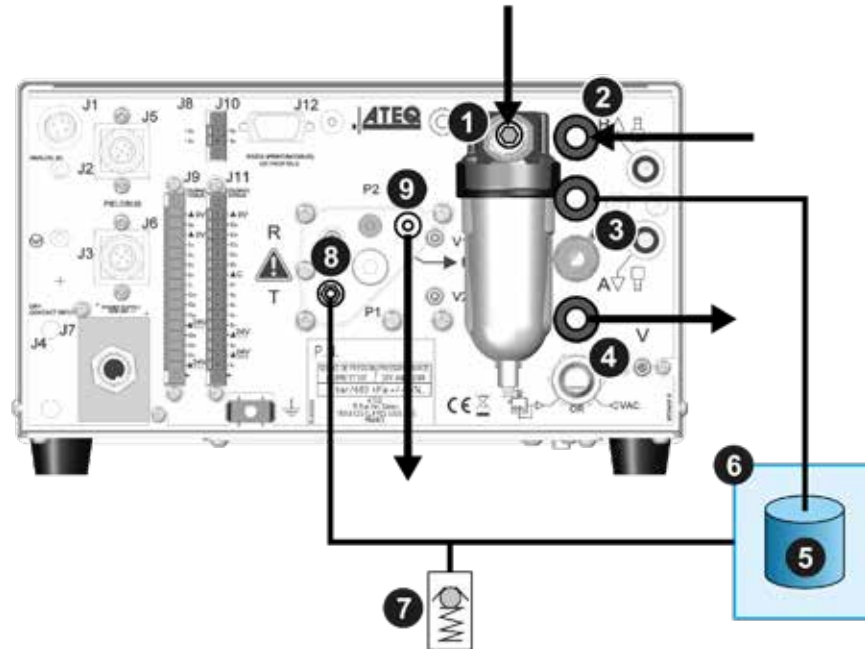

Connections

Connection	Option / description
Regulator air supply to 1	Connection of the regulator air supply to the filter input (1.2 MPa (174 PSI))
Air supply to 2	Connection of the air supply (0.6 MPa (87 PSI))
3 to 5	Connection of the regulator output to the part under test
8 to 6	Connection of the test output to the bell secured by a security valve 7
4 to ATM	Connection of the test part exhaust to the atmosphere
9 to ATM	Connection of the bell exhaust to the atmosphere



Direct mode - Sealed part test

Pressure: from 0 to 500 kPa (72.5 PSI)

This configuration can be used for test of small test part volumes.

 Protect volumes and pipes from air blowing and temperature variations.

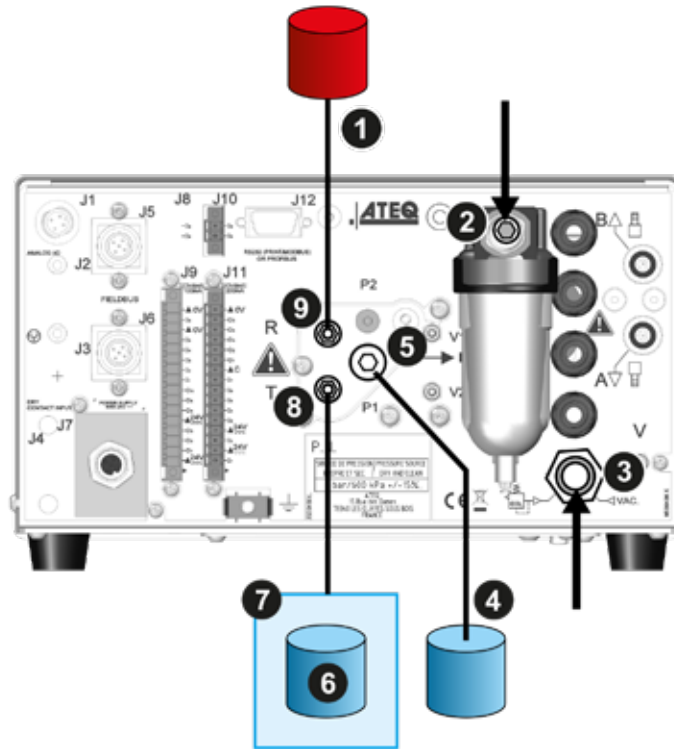

Connections

Connection	Option / description
9 to 1	Connection of the reference output to the reference part
8 to 7	Connection of the test output to the bell 7 including the part under test 6
5 to 4	Connection of the P1 output to a transfer volume
Air supply to 2	Connection of the air supply to the filter input (0.6 MPa (87 PSI))
Vacuum to 3	Connection to the vacuum (option)



Direct mode - Sealed part differential volume test

Pressure: from 0 to 500 kPa (72.5 PSI)

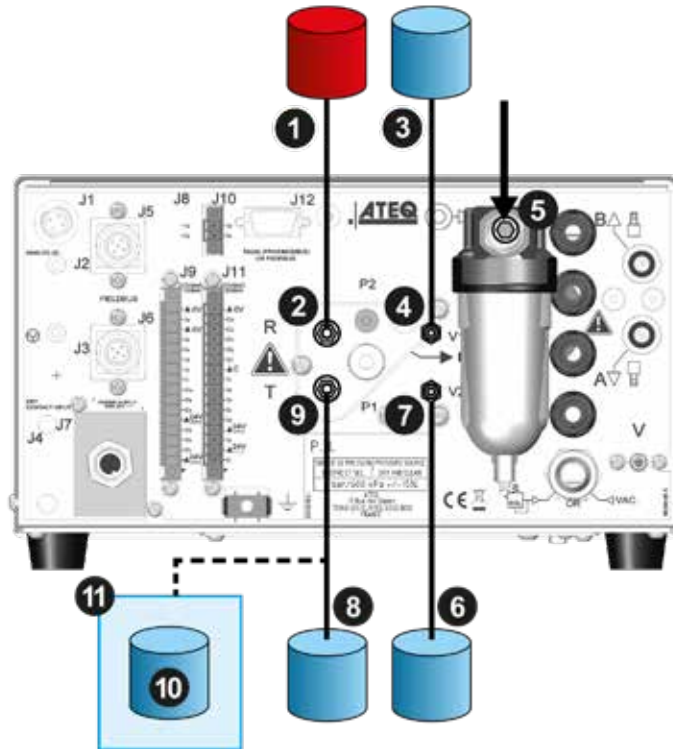

Connections

Connection	Option / description
2 to 1	Connection of the reference output to the reference part
9 to 8	Connection of the test output to the part under test 8
Or 9 to 11	Connection of the test output to the bell 11 including the part under test 10 for differential volume test
4 to 3	Connection of the V1 output to the reference transfer volume
7 to 6	Connection of the V2 output to the test transfer volume
Air supply to 5	Connection of the air supply to the filter input (0.6 MPa (87 PSI))



Direct mode - Option test check by pressure drop

Pressure: from 0 to 500 kPa (72.5 PSI)

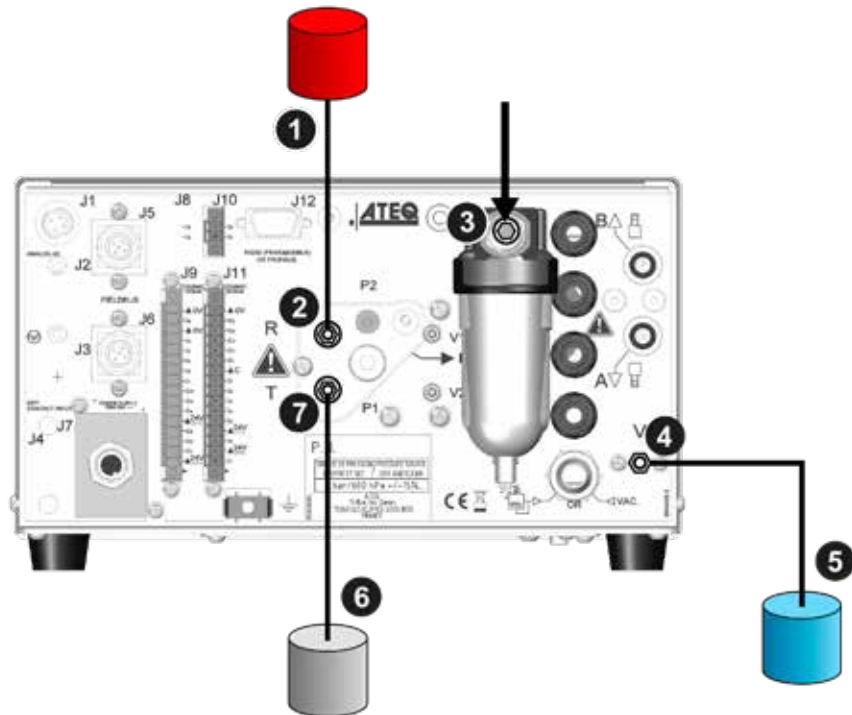

Connections

Connection	Option / description
2 to 1	Connection of the reference output to the reference part
7 to 6	Connection of the test output to the part under test 6
Air supply to 3	Connection of the air supply to the filter input (0.6 MPa (87 PSI))
4 to 5	Connection of the V output an additional volume



User interface

32/46

OVERVIEW

The user interface comprises a display and user keys located on the front panel.





- 1 Display
- 2 Cycle keys
- 3 Navigation keys

KEYS

Cycle keys

The cycle keys are used to start and to stop a measurement cycle.

Key	Name	Function
	Start	On the Program screen, starts a measurement cycle and opens the Measurement cycle screen.
	Reset	Stops the measurement cycle in progress and returns to the Program screen.



Navigation keys

The navigation keys are used to select menus/options and change parameter values.

Key	Name	Function
	Up key	Scrolls up or increases numerical values.
	Down key	Scrolls down or decreases numerical values.
	OK	Returns to the MAIN MENU screen or opens menus and options, validates parameters.
	Esc	Returns to previous screen (until the Program screen), escapes without modifying parameters.

Smart key

Smart key is a programmable key that provides direct access to a function selected by the user.

Key	Name	Function
	Smart key	Starts a measurement cycle (default, programmable).

This key is programmable through the **MAIN MENU** screen:
MAIN MENU > CONFIGURATION > MISCELLANEOUS > SMART KEY

DISPLAY

The device uses 4 main screens.

The Program screen

Use the **Program** screen to select a test program.

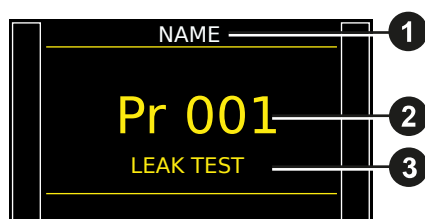

- 1 Current program name (here **NAME**)
- 2 Current program number (here **001**)
- 3 Test type (here **LEAK TEST**)

Access at start-up of the instrument or by pressing several times **Esc** .



The Measurement cycle screen

The Measurement cycle screen displays the different values of the current test (or last one).

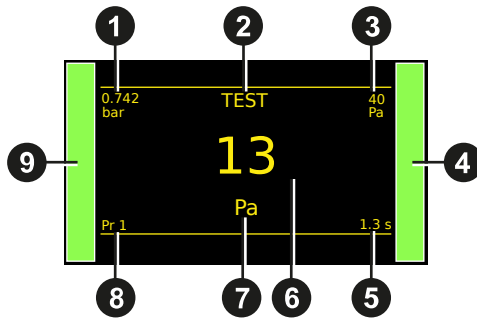

- 1 Test pressure measurement
- 2 Test result or step phase
- 3 Test reject value
- 4 Vertical line test result
- 5 Remaining time of the current phase or ready status
- 6 Leak measurement
- 7 Measurement unit
- 8 Current program
- 9 Vertical line test result

i A star (*) can be displayed after the measurement unit **7** when the standard conditions function is validated.
Refer to the Reference Manual.

The MAIN MENU screen

The MAIN MENU screen gives access to different sections for managing the device and the test parameters.

i Access: from the **Program** screen, press **OK**.

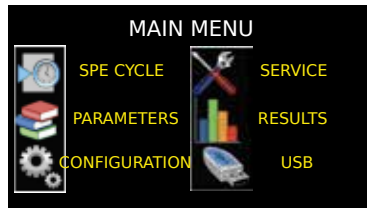

Option	Description
SPE CYCLE	Specific procedures necessary to ensure the proper operation of specific measurement cycles (for example, adjustment of a pressure regulator).
PARAMETERS	Parameters of the test programs.
CONFIGURATION	General configuration of the device.
SERVICE	Maintenance of the device.
RESULTS	Test results, backup and display options.
USB	USB connection functions (backup, restore).





Starting up

POWER UP

1. Make sure that all the necessary connections are in place.

Electrical: such as power supply, inputs/outputs
Pneumatic: including line pressure supply

2. Power up your device.

When power-up is completed, the **Program** screen is displayed with last program used on screen.

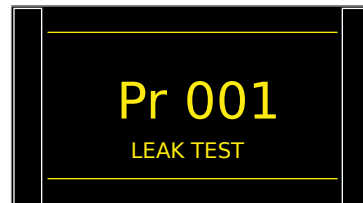

PREPARING A PROGRAM

Use this procedure to configure a new test program.

On the **MAIN MENU** screen:

ACCESSING THE PARAMETERS

1. Select **PARAMETERS** using the up/down keys and press **OK**.

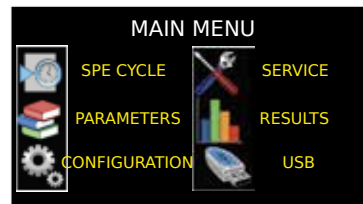

The program list is displayed.

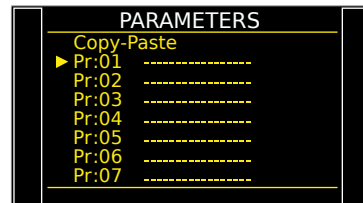

SELECTING A PROGRAM NUMBER

2. Select the program to configure and press **OK**.

A list of the available measurement types is displayed:

- **LEAK TEST** type
- **BLOCKAGE** type (option)
- **DESENSITIZED TEST** type (option)
- **OPERATOR** type (option)
- **BURST TEST** type (option)
- **VOLUME** type (option)

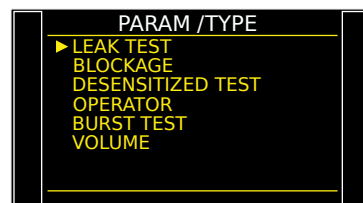



CONFIGURING THE ASSOCIATED MEASUREMENTS

3. Select a measurement type and press

The parameters of the selected measurement type are displayed.

4. Define the measurement cycle parameters.

See: Modifying a parameter.

PARAM / Pr 001	
▶TYPE :	LEAK TEST
COUPL. A :	0.0 s
FILL TIME :	2.0 s
STAB TIME :	2.0 s
TEST TIME :	2.0 s
DUMP TIME :	1.0 s
Press. UNIT :	bar
Max FILL :	5.00

MODIFYING A PARAMETER

Use this procedure to complete the test program setup.



The protection of the parameters is configurable. If the icon is displayed at the bottom of the screen, you must insert the USB unlocking device or enter a password before modifying a parameter.

On the **PARAMETERS** screen of the program (see: Preparing a program):

1. Press up/down to select the parameter to modify, and press .

PARAM / Pr 001	
TYPE : LEAK TEST	
COUPL. A :	0.0 s
FILL TIME :	2.0 s
STAB TIME :	2.0 s
▶TEST TIME :	2.0 s
DUMP TIME :	1.0 s
Press. UNIT :	bar
Max FILL :	5.00

An arrow is displayed on the right of the parameter being modified.

PARAM / Pr 001	
TYPE : LEAK TEST	
COUPL. A :	0.0 s
FILL TIME :	2.0 s
STAB TIME :	2.0 s
TEST TIME :	2.0 s ◀
DUMP TIME :	1.0 s
Press. UNIT :	bar
Max FILL :	5.00

2. Use the up/down up/down keys to modify the parameter value, and press to validate.

The arrow returns to the left of the modified parameter.

PARAM / Pr 001	
TYPE : LEAK TEST	
COUPL. A :	0.0 s
FILL TIME :	2.0 s
STAB TIME :	2.0 s
▶TEST TIME :	1.0 s
DUMP TIME :	1.0 s
Press. UNIT :	bar
Max FILL :	5.00

3. Repeat these steps until all parameters are set.

4. To return to the **MAIN MENU** screen, press Esc as many times as necessary.



SELECTING A PROGRAM

If necessary, you can select another program.

1. Press up/down .

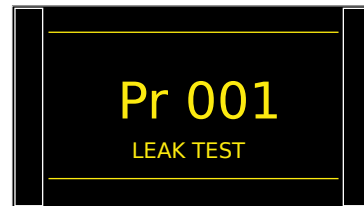

37/46

STARTING AND STOPPING CURRENT CYCLE

Use the front panel keys to start/stop a measurement cycle.
With the desired program displayed on the **Program** screen:

STARTING A MEASUREMENT CYCLE

1. Press Start .

The cycle phases of the program are successively displayed:

FILL
STABILISATION
TEST
DUMP

At the end of the cycle, the results are displayed and **READY** appears at the bottom right of the screen.

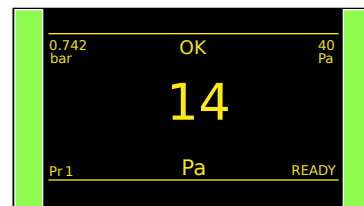

During the measurement cycle, you may press to access the **MAIN MENU** screen and set parameters for a next measurement cycle.

STOPPING A CYCLE

2. Press Reset to immediately stop the current measurement cycle and return to the **Program** screen.



User adjustments

OPTIONS OF THE MENU

Different menus are accessible on the **MAIN MENU** screen.

i | For more information, refer to the Reference Manual.

SPE CYCLE menu

Use this menu to carry out specific procedures necessary to ensure the proper operation of specific measurement cycles (for example, adjustment of pressure regulator).

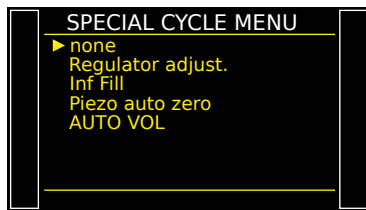

Label	Special cycle	Description of the cycle
none	None	No special cycle selected
Regulator Adj.	Regulator adjustment	Adjustment of regulator in front panel
Inf Fill	Infinite fill	Pressurize the part with a infinite fill time
Piezo auto zero	Piezo auto zero	Auto zero cycle on the piezo sensor
AUTO VOL	Automatic volume	Volume calculation for automatic program selection



i | Some parameters are displayed when specific functions are activated.

Label	Special cycle	Description of the cycle
Part. Regulator Adj.	Part regulator adjustment	Regulator adjustment for indirect mode
Custom Unit Learn	Custom unit learn	Define unit on a master leak
Custom Unit Check	Custom unit check	Check correct unit learning on a master leak
Chck+Lrn Cust. Unit	Custom unit check and learn	Check correct unit learning and relearn if necessary
Sd Prt PASS Learn	Sealed part pass learn	Mandatory cycle for sealed part test mode
Sd Prt FAIL Learn	Sealed part fail learn	Reject level adjustment for sealed part test mode
LEAK OFFSET LEARN	Leak offset learn	Special cycles to determine offset parameters
OFFSET+VOL. LEARN	Offset and volume learn	Special cycles to determine offset and volume parameters (Flow unit)
N START	Number start cycle	Launch a determined quantity of cycles





TO START SPECIAL CYCLES...

1. On the **SPECIAL CYCLE MENU** screen, select a cycle, and press **OK** to validate.
2. Press **Start**  to start the cycle.
3. To stop the current cycle press **Reset** .

PARAMETERS menu

Use this menu to configure the measurement cycle associated to each test program.

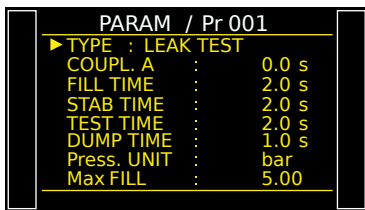

Default parameters of the **LEAK** type tests

Label	Parameter	Description
COUPL. A or COUPL. B	Coupling time	Required times when instrument manage automatic jigs
FILL TIME	Fill time	Time to pressurise the part under test
STAB TIME	Stabilization time	Time to stabilise the pressure on the test and reference parts
TEST TIME	Test time	Time for leak measurement
DUMP TIME	Dump time	Time to vent the part to atmosphere
Press. UNIT	Pressure units	Pressure unit (bar, mbar, PSI, Pa, kPa, MPa)
Max FILL	Maximum fill pressure	Maximum level of the fill pressure
Min FILL	Minimum fill pressure	Minimum level of the fill pressure
LeakUnit	Reject unit	Measurement units
Test FAIL	Test fail	Upper leak rate limit for the test part. Above this limit, the part is considered as defective.
Ref. FAIL	Reference fail	Reference part reject level
FUNCTIONS	Functions	Access to additional functions



Some parameters are displayed when specific functions are activated.

Label	Parameter	Description
INTER-CYCLE	Inter cycle time	Time between two automatically chained programs (Sequence function)
Max PreFILL	Max pre fill pressure	Maximum level of the pre fill pressure (Pre fill function)
OFFSET	Leak offset	Leak offset value
PRE DUMP	Pre dump time	Time to dump the part under test (Pre fill function)





Label	Parameter	Description
PRE-FILL	Pre fill time	Time to pressurise the part under test (Pre fill function)
REJECT CALC.	Reject calculation	Define raw unit to calculate flow unit (Flow unit)
Set FILL	Set fill	Fill pressure instruction (Fill function or electronic pressure regulator)
Set PreFILL	Pre fill pressure	Pre fill pressure instruction (Pre fill function)
VOLUME	Test volume	Complete volume of the test part (Flow unit)
Volume UNIT	Volume unit	Volume unit of the test part (Flow unit)

Additional functions

Label	Function	Description
24V OUTPUTS	Auxiliaries output 24 V	Available outputs for external automatism
ABSOLUTE	Absolute	Display the absolute value of the results
ATF	ATF time	Absorb the important leak variations at the defined time
ATRO/ATR1 / ATR2/ATR3	ATR 0 - 3	Specific filters on leak measurement
AUTO CONNECT	Automatic connector	Function to manage automatic jigs
BUZZER	Buzzer	Buzzer activation configuration
BYPASS	Bypass function	Additional valve for faster filling
CODE READER	Bar code reader	Bar code configuration
CUT OFF	Cut off	All the measurements that are lower than the configured rate have the value 0
DISP. OPT.	Display option	Display of an additional information on a second line
DISPLAY MODE	Display Mode	Leak measurement resolution
END OF CYCLE	End of cycle	Several automatism case depending on fail part management
FILL MODE	Fill types	Special filling methods
FILTER	Filtering	Stabilize the measurement values
FLOW LEVEL	Flow level	Add a minimum fail parameter
INDIRECT	Indirect mode	Specific test mode: test part under bell
MINI-VALVE	Mini valve	Access to highest time resolution (fast test) and auto zero time
NAME	Name	Program customization
NO NEGATIVE	No Negative	Replace negative value per 0
N TESTS	N TESTS	Repeats the test when the results get close to the reject level
PEAK HOLD	Peak hold	Give as result, the highest flow during the test time
PR:SEQUENCE	Sequencing	Allowed program automatic sequencing
PRE-FILL	Pre-fill types	Special filling methods
PRESS.CORR.	Pressure correction	Calculates leak at a defined pressure value
PRESSURE DROP	Pressure drop	Pressure drop mode function in the Desensitized mode



Label	Function	Description
REF. VOLUME	Reference volume	Adjust the reference volume value with flow units only
REWORK LIMIT	Rework limits	Additional levels for specific reworkable parts
Sd Part SD PART 2 SD PART 3	Sealed part	Several optional ways to test sealed parts
SEALED DIFF	Sealed differential	Allows testing small parts volume difference between test and reference volumes
SIGN	Sign	Return opposite result
STAMPING	Stamp	Pneumatic or electric output to identify the part
STD CONDITIONS	Standard conditions	Standard conditions correction with parameters
SYNC. TEST	Synchro test	A programmable input allows to pass from Stabilization to Test phase
T+R TEST	Test and reference test	Display which part has failed during a test with two parts
TEMP.CORR. 1	Temperature correction	Software temperature test part correction
TEMP.CORR. 2	Temperature correction	Hardware temperature test part correction
TEST CHECK	Calibration check	Calibration check by adding a volume at the end of test time
TEST TIME*100	Longer test time	Allowed longer test time (1s = 100s)
UNITS	Units	Access to International System or American or Custom Units
VALVE CODES	Valve codes	Available outputs for external automatism

 Some functions are available depending on software version.





CONFIGURATION menu

Use this menu to configure your ATEQdevice.

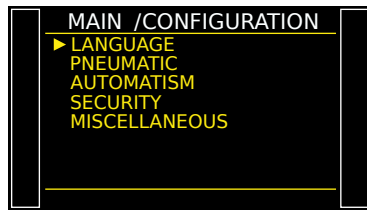
42/46



Label	Function	Description
LANGUAGE	Language	Selection of the language displayed on the screen
PNEUMATIC	Pneumatics	Configuration of the pneumatics functions of the device
> AUTO VOL	-	Configuration of volume calculation for automatic program selection (option)
> ELEC. REG.	-	Activation of the electronic regulator
> REGUL. CTRL.	-	Configuration of the electronic regulator (external or auto) (option)
> PERM. REG.	-	The electronic regulator is active every time
> PIEZO AUTO AZ	-	Configuration the frequency of the auto zero
> AZ SHORT	-	Deactivation of the linearization of the regulator during the auto zero process (option)
> Press. UNIT	-	Pressure unit by default for the new programs
> DUMP LEVEL	-	Configuration of the minimum dump level pressure
> LINE P. MIN	-	Minimum level for checking line pressure (option)
> BLOW MODE	-	Blowing mode when test cycle is not running (option)
> EXT. DUMP	-	Configuration of the external dump (option)
> DUMP OFF	-	Remove dump time parameter on the selected program that becomes 0 second
AUTOMATISM	Automatism	Configuration of the different communications between the device and its environment
> RS232	-	Configuration of the communication type on the RS232 port
> USB	-	Configuration of the connection type on the USB port
> Date & Time	-	Setup of the built-in clock
> OUTPUTS CONFIG.	-	Configuration of the programmable outputs
> INPUTS CONFIG.	-	Configuration of the programmable inputs
> CODE READER	-	Bar code reader configuration
SECURITY	Security	Security functions
> ACCESS	-	Parameters access mode (key or password)
> START OFF	-	Deactivation of the Start  on the instrument front panel. Programs can only be started from the instrument relay board.
MISCELLANEOUS	Miscellaneous	
> SMART KEY	-	Configuration of the assigned function to the Smart key 



SERVICE menu

Use this menu to do the maintenance of your device (status check, internal tests...).

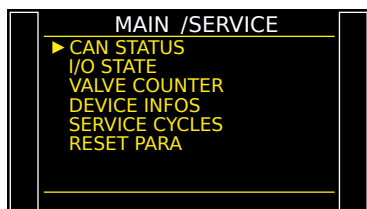

Label	Function	Description
CAN STATUS	Internal network state	State of the internal network of the device
I/O STATE	Inputs/outputs state	State of the inputs/outputs
VALVE COUNTER	Valves wear function	Approximate state of the valves wear
DEVICE INFOS	Device information	Information about the device, program version, built in components etc.
SERVICE CYCLES	Special service cycles	Allows to display more special cycles to carry out device internal tests (see Service special cycles)
RESET PARA	Parameters reset	Reset to factory configuration
FIELDBUS	Fieldbus parameters	Fieldbus information

RESULTS menu

In this section, manage measurements results.

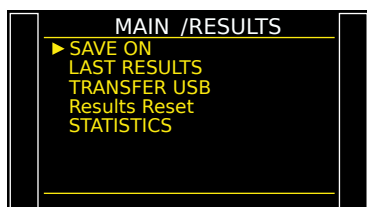

Label	Function	Description
SAVE ON	-	Define memory location (internal or external USB stick)
LAST RESULTS	Results display	Last 1500 results carried out by the device
TRANSFER USB	Results transfer	Transfer all results to USB stick on CSV file
Results Reset	Results erasing	The results are lost after the reset!
STATISTICS	Results statistics	Statistics for each program



USB menu

This section describes save and restore parameters on an external USB device.

44/46

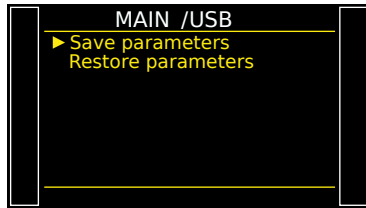

Label	Description
Save parameters	Save parameters on an external USB memory device for restoring later
Restore parameters	Restore parameters from an external USB memory device



Specifications

CHARACTERISTICS

Technical characteristics of the device.

Main characteristics

Characteristics	Values
Case dimensions: Height x Width x Depth	150 x 250 x 270 mm (5.91 x 9.84 x 10.63")
Overall dimensions	150 x 250 x 360 mm (5.91 x 9.84 x 14.17")
Format	Half 19-inch rack
Mass	About 8 kg (17.6 lbs)
Electrical power supply	– 100 / 240 V AC - 50 W - 50/60 Hz – 24 V DC - 2 A.
Overvoltage category	II
Pneumatic air supply (0 to 0.5 MPa (0 to 72.5 PSI) range)	Air supply: 0.6 MPa (87 PSI) \pm 15%
Pneumatic air supply (0.6 to 1 MPa (87 to 145 PSI) range)	– Regulator input: 1.2 MPa (174 PSI) \pm 10% – Valves supply: 0.6 MPa (87 PSI) \pm 15%
Pneumatic air supply (1.1 to 2 MPa (160 to 290 PSI) range)	– Regulator input: instrument pressure range + 0.1 to 0.2 MPa (14.5 to 29 PSI) – Valves supply: 0.6 MPa (87 PSI) \pm 15%
Protection	Device protection level IP2
Pneumatic connections: (inside / outside diameters)	2.7/4 to 6/8 mm
Operation temperature	+5 °C to + 45 °C (+ 41 °F to 113 °F)
Storage temperature	0 °C to +60 °C (32 °F to 140 °F)
Operation altitude	Up to 2000 m (6500 ft)
Relative humidity	80 % at 31 °C (87 °F) and 50 % at 40 °C (104 °F)

